

# **User Manual**

**Dental Unit KLT-6210, KLT-6220**

D001

Version: 2.2 10.2020

1

Roson Dental Unit  
Operating Instructions KLT-6210、KLT - 6220

Table of contents

## Table of contents

1	General information.....	4
1.1	Dear Customer,.....	4
1.2	Contact information.....	4
1.3	Notes on these Operating Instructions.....	4
1.3.1	General information on the Operating Instructions.....	4
1.3.2	Scope of these Operating Instructions.....	4
1.4	Other valid documents.....	5
1.5	Warranty and liability.....	5
1.6	Intended use.....	5
1.7	Contraindication.....	5
2	Safety information.....	6
2.1	Identification of danger levels.....	6
2.2	Information on the unit.....	6
2.3	On-site installation.....	6
2.4	Media quality.....	6
2.5	Maintenance a repair.....	7
2.6	Trouble-free operation.....	7
2.7	Patient chair.....	7
2.8	Ventilation slots.....	7
2.9	Continuous operation.....	7
2.10	Care and cleaning agents.....	8
2.11	Modifications and extensions of the unit.....	8
2.12	Electromagnetic compatibility.....	8
2.13	Dismantling/Installation.....	8
3	Unit description.....	9
3.1	Standards/approvals.....	9
3.2	Technical data.....	9
3.3	Dental unit overview.....	11
4	Installation and debugging	
4.1	Installation condition.....	12
4.2	Installation preparing.....	12
4.3	Installation.....	113
4.3.1	Installation of chair base.....	13
4.3.2	Installation of patient chair.....	13
4.3.3	Installation of pipe.....	113
4.4	Debugging.....	14

D001

Version: 2.2 10.2020

**2**Roson Dental Unit  
Operating Instructions KLT-6210、KLT - 6220

Table of contents

4.5 Debugging.....	15
<b>5 Operation.....</b>	<b>126</b>
5.1 Starting up the dental unit.....	16
5.1.1 Initial startup.....	16
5.1.2 Switching the dental unit on/off.....	16
5.2 Foot control.....	16
5.3 Patient chair.....	17
5.3.1 Safety instructions.....	18
5.3.2 Armrest.....	19
5.3.3 Adjusting the headrest.....	19
5.3.2 Moving the patient chair.....	19
5.3.3 Moving the patient chair to the entry/exit position.....	20
5.3.4 Moving the patient chair to the general working position.....	20
5.4 Dentist element.....	21
5.4.1 Maximum load capacity.....	22
5.4.2 Height adjustment.....	19
5.4.3 The control panel on the dentist element.....	20
5.4.4 X-ray viewer.....	23
5.4.5 Placing the instruments in their holders.....	23
5.4.6 Operating the handpieces.....	24
5.4.7 Adjusting the handpiece's working air pressure and water flow.....	24
5.4.8 3-way syringe.....	25
5.5 Assistant element.....	25
5.5.1 Moving the assistant element.....	26
5.5.2 The control panel on the assistant element.....	26
5.5.3 3-way syringe.....	27
5.5.4 Saliva ejector.....	27
5.5.5 Spray aspirator.....	27
5.6 Water unit.....	27
5.6.1 Tumbler filler.....	28
5.6.2 Flushing the swiveling cuspidor bowl.....	28
5.6.3 Swiveling cuspidor bowl.....	28
5.6.4 Air switch.....	28
5.6.5 Water alternative switch.....	28
4.6.6 Pure water bottle.....	28
5.7 Operating light.....	29
<b>6 Cleaning and maintenance by the practice team.....</b>	<b>29</b>
<b>7 Maintenance by the service engineer.....</b>	<b>33</b>

D001

Version: 2.2 10.2020

**3**

Roson Dental Unit

Operating Instructions KLT-6210、KLT - 6220

Table of contents

7.1	Inspection and maintenance.....	33
7.2	Safety checks.....	33
8	Malfunctions.....	34
9	Disposal.....	35
10	Overview of graphic symbols used.....	36
11	Electrical schematic diagram.....	38
12	Water-air layout diagram.....	39
13	EMC Guidancet.....	40

## 1 General information

### 1.1 Dear Customer,

We are pleased that you have equipped your practice with the our dental unit. With our device you have chosen a dental unit that stands for easy operation, innovative comfort and high quality design.

These Operating Instructions are designed to assist you prior to initial use and whenever you require information later on.

We wish you a great deal of success and pleasure with our device.

### 1.2 Contact information

#### Customer service center

Our Chinese and English speaking Product Service staff are ready to answer your technical questions by telephone from 8:30 a.m. to 5:00 p.m. BJT. Outside of these times, please contact us via fax or e-mail.

Phone: +86-757-86407037

Fax: +86-757-86407038

E-mail: [sales001@fsroson.com](mailto:sales001@fsroson.com)

Manufacturer: Foshan Roson Medical Instrument Co., Ltd

Add: No.9 Henggui ZhongRoad, Lianhe Avence, Luocun, Shishan Town, Nanhai District, Foshan City, Guangdong 528226 P.R. China

EU Authorized Representative: Buldenteks Ltd

Address: Radomir 2400 ul. Mircho Hristov No 7, Bulgaria.

Tel: 359 887698924 Fax: 359 887698924

Email: [office@buldenteks.bg](mailto:office@buldenteks.bg)

### 1.3 Notes on these Operating Instructions

#### 1.3.1 General information on the Operating Instructions

#### Observe the Operating Instructions

Please familiarize yourself with the unit by reading through these operating instructions before putting it into operation. It is essential that you comply with the specified warning and safety information. Please note pictures of this user manual is based on KLT-6210. KLT-6220 is updated version, adds some handy operation and has more excellent appearance. Specific of KLT-6220 please in kind prevail!

#### Keep documents safe

Always keep the Operating Instructions handy in case you or another user require information at a later point in time.

#### Help

If you reach an impasse despite having thoroughly studied the Operating Instructions, please contact your dental suppliers.

#### 1.3.2 Scope of these Operating Instructions

This document describes the full version of your unit. It may therefore

cover components that are not included in the unit you purchased.

#### 1.4 Other valid documents

You dental unit can be equipped with additional components that are described in separate sets of operating instructions. The instructions as well as any warning and safety information contained therein also must be observed.

#### 1.5 Warranty and liability

##### Warranty Passport

To safeguard your warranty claims, please complete the attached “Warranty Passport” together with the service engineer immediately after the installation of your unit.

##### Maintenance

Maintenance must be performed at scheduled intervals to ensure the operational and functional reliability of your product and to protect the safety and health of patients, users and other persons. For more information, please refer to “Maintenance by the service engineer”.

The owner is responsible for making sure that all maintenance activities are performed.

As manufacturers of medical electrical equipment, we can assume responsibility for the safety properties of the unit only if maintenance and repairs on the unit are performed either by us or by agencies which we have expressly authorized and if components of the unit are replaced by original spare in case of failure.

##### Exclusion of liability

In the event that the unit owner fails to fulfill its obligation to perform maintenance activities or ignores error message, we cannot assume any liability for any damage thus incurred.

#### 1.6 Intended use

This dental unit is intended for the diagnosis, therapy and dental treatment of humans by properly trained and qualified personnel.

This device is not intended for operation in areas subject to explosion hazards.

Intended use also includes compliance with these Operating Instructions and the relevant maintenance instructions.

#### 1.7 Contraindication

Highly immunosuppressed patients should not come in contact with water from the unit. The use of sterile solution is recommended.

## 2 Safety information

### 2.1 Identification of danger levels

To prevent personal injury and material damage, please observe the warning and safety information provided in this document. Such information is highlighted as follows:



#### WARNING

A possibly dangerous situation that could result in serious bodily injury or death.



#### NOTICE

A possibly harmful situation which could lead to damage of the product or an object in its environment.

#### IMPORTANT

Application instructions and other important information.



### 2.2 Information on the unit

Two symbols can be found on the unit rating plate.

### 2.3 On-site installation

The on-site installation must have been performed according to our requirements. The details are described in the document "Installation Requirements."

### 2.4 Media quality

The air and water supplies must meet the requirements specified in the technical data. Use only drinking water and dry, oil-free and hygienically clean air for the water and air supplies of the unit.

**As the owner of the unit, you are generally responsible for the water quality.** For this reason, you should check the water quality at regular intervals. Please contact your specialized dealer or your relevant dental association for the respective national requirements and measures.

Highly immunosuppressed patients should not come in contact with water from the unit. The use of sterile solution is recommended.

## 2.5 Maintenance a repair

### Authorized technical personnel and spare parts

As manufacturers of dental units and in the interest of the operational safety of your unit, we stress the importance of having maintenance and repair of this unit performed only by ourselves or by agencies expressly authorized by us. Furthermore, failed components must always be replaced with original spare parts.

### Maintenance intervals

In order to ensure the operational safety and reliability of your unit and to avoid damage due to natural wear, you as the unit owner must have your unit checked regularly by an authorized service engineer. Furthermore, safety checks must be performed. Please contact your dental depot to obtain a maintenance offer. For more information, please refer to "Maintenance by the service engineer".

## 2.6 Trouble-free operation

Use of this unit is permissible only if it works properly without malfunctions. If trouble-free operation cannot be ensured, the unit must be taken out of service, checked by authorized technicians for malfunctions and, if necessary, repaired.

## 2.7 Patient chair

Please observe the maximum load capacity of **150 kg** for the patient chair.

The weight distribution complies with the **ISO 7494-1:2018** standard. The safety test is according to IEC60601-1:2005+A1:2012.

**The patient's arms and legs must be testing on the upholstery of the chair.**

## 2.8 Ventilation slots

Under no circumstances may the ventilation slots on the unit be covered, since otherwise the air circulation will be obstructed. This can cause the unit to overheat.

Do not spray liquids such as disinfectants into the ventilation slots. This may lead to malfunctions. Use wipe disinfection only in the vicinity of the ventilation slots.

## 2.9 No-continuous operation

**The type of operation mode: Intermittent motion, it must rest for at least 18 minutes after keep moving for a period of Max. 2 minutes**

Duty cycle of drive motors for patient chair and backrest: Max.2min on./ Min. 18min off.



## **2.10 Care and cleaning agents**

Unsuitable care and cleaning agents may corrode the surface of the unit. Therefore, use only care and cleaning agents which have been approved by Roson. For more information, please refer to "Care and cleaning agents".

## **2.11 Modifications and extensions of the unit**

Modifications to this unit which might affect the safety to the unit owner, patients or other persons are prohibited by law.

For reasons of product safety, this product may be operated only with original Roson accessories or third-party accessories expressly approved by Roson. The user assumes the risk of using non-approved accessories.

## **2.12 Electromagnetic compatibility**

Medical electrical devices are subject to special precautionary measures with regard to electromagnetic compatibility (EMC).

Portable and mobile RF communications equipment may interfere with medical electrical equipment. Therefore, the use of such devices (e.g. cellular phones) in practice of hospital environments must be prohibited.

## **2.13 Dismantling/Installation**

When dismantling and reinstalling the unit, proceed by ourselves or by agencies expressly authorized by us in order to guarantee its proper functioning and stability.

### 3 Unit description

#### 3.1 Standards/approvals

The KLT-6220 and KLT-6210 dental unit complies with the following standards, among others:

- IEC 60601-1:2005+A1:2012 / EN 60601-1:2006+A1:2013
- IEC 60601-1-2:2014 / EN 60601-1-2:2015
- IEC 60601-1-6:2010+A1:2013 & IEC62366-1:2015 / EN 60601-1-6:2010 +A1:2015 & EN62366-1:2015+AC:2015
- EN ISO 7494-1:2018
- EN ISO 7494-2:2015
- ISO 9680:2014

This product bears the CE mark in accordance with the provisions of Council Directive 93/42/EEC of 14 June 1993 concerning medical devices.

#### 3.2 Technical data

Model designation:	KLT-6220, KLT-6210
Input max power:	720 VA
Power connection:	230 V AC 50/60 Hz
Rated current:	3.15 A at 230 V
Fuse for the unit:	Ø5X20 F6.3A H 250VAC
Protection class:	Class I equipment
Degree of protection against electrical shock:	 Type B applied parts
Degree of protection against ingress of water:	<b>Main unit: IPX0</b> <b>Foot controller: IPX4.</b>
Mode of operation:	<b>Non-continuous operation for dental chair motor: Max. 2 min. ON / 18 min. OFF</b>
Transport and storage conditions:	Temperature: -40 °C – +70 °C Relative humidity: 10% – 95% Barometric pressure: 500 hPa – 1060 hPa
Operating conditions:	Ambient temperature: 5 °C – 40 °C Relative humidity: 30% – 85% Barometric pressure: 540 hPa – 1060 hPa

D001

Version: 2.1 10.2012

10

3 Unit description	Roson Dental Unit Operating Instructions KLT-6210、 KLT - 6220
--------------------	--

Water supply:	Water pressure: 0.2Mpa – 0.4MPa Water flow: $\geq 5\text{L/min}$ hardness $< 25$ Incoming water temperature Max. $30\text{ }^{\circ}\text{C}$
---------------	--

Air supply:	Air pressure: 0.55MPa – 0.8MPa Air flow: $\geq 90\text{L/min}$
-------------	---

Handpiece capacity :	Handpiece air output pressure: 0~0.4MPa Water Pressure: 0.2MPa Scaler water output pressure: 0.2MPa
----------------------	---

Net weight:	About $230\text{kg}$ (for KLT-6220) About $180\text{kg}$ (for KLT-6210)
-------------	--

The height of patient chair:	$400\sim 750\text{mm}$ +/-10mm
------------------------------	--------------------------------

The movement range of patient chair:	Backrest movement range: $115^{\circ}\sim 170^{\circ}$ Max. headrest rack extension 120mm
--------------------------------------	--

Installation site:	$\leq 3000\text{m}$ above sea level
--------------------	-------------------------------------

Tests/Approvals:	See "Standards/Approvals"
------------------	---------------------------

Year of manufacture:	 20XX (on the rating plate)
----------------------	--

Software version: V1.0

### 3.3 Dental unit overview

The dental unit comprises the following main components:



A	Main switch (water, air and power)
B	Patient chair
C	Foot control
D	Headrest
E	Assistant element
F	Swiveling cuspidor bowl
G	Bowl flushing system
H	Tumbler filler
I	Water unit
J	Operating light
K	Dentist element
L	X-ray viewer

## 4 Installation and debugging



The device should be installed and debugged by professional engineer specified by Manufacturer. If the user installs and debugged by themselves, it could occur unexcepted risk.

### 4.1 Product list

The product list is as below. After open the package, please check all components are completed according to the product list.



If there are some components is missing, please contact with Manufacturer.

No.	Components name
1	Main dental unit
2	Light arm, Light lamp.
3	Operation light、Flushing sputum faucet、water faucet、Bowl filter、Bowl filter cap、light lame set、Swiveling cuspidor bowl
4	Foot control
5	Chair base
6	Headrest
7	Backrest
8	Seat
9	Doctor chair(Seat、Gas spring、gyro wheel、Gas spring set、Backrest、Chair base)
10	3-way syringe、Strong suction, weak Suction
11	3-way syringe pipe、Handpiece pipe
12	User manual、Certificate of quality, Warranty card, Components list, 3-way syringe tips, protection tube、Inflow switch、Single-use straw, Socket head wrench, Leveling screw, Backrest screw

### 4.2 Installation condition

The minimum dimensions (length\*width\*height) of installation room is 2800x2500x2500mm. The floor of installation room must be level and horizontal  $\leq 3/2000$ mm. The minimum load-bearing capacity of the floor must be 0.5 N/cm<sup>2</sup> (around 500 kg/m<sup>2</sup>).

Notice: If there is necessary, please reinforce the surface beneath the floor.

For ensuring the normal use of dental units, the technical requirements of inputting air, water and electric power and environment are as

following:

Electric voltage: 230V±10%, 50/60Hz

Inputting air pressure: 0.55MPa~0.8MPa, flow:  $\geq 90\text{L/min}$ ;

Inputting water pressure: 0.2MPa~0.4MPa, flow:  $\geq 5\text{L/min}$ ;

**Notice:** It would affect the normal use of dental unit if the water pressure is too low or too high;

The quality of incoming water to be supplied to the dental unit should be in compliance with existence of national regulations. The following values are recommendations:

Water hardness limit: less than 2.14 mmol/l (<12° dH)

PH limit: 6.5-8.5

Maximum particle size <100 $\mu\text{m}$ ;

The compressed air provided for the dental unit should contain no oil and relevant requirement for cleanness should be met. The air compressor should be provided by the user and compressed air must be subject filtration with a filter pore size  $\leq 50\mu\text{m}$ .

- If the compressed air with too much water, please get rid of the water inside compressor in time.
- If the working environment is humid, it is better to add a cooling and drying device to the air compressor;

Suction (low) is water suction. Connection through water source is required, and minimum water level is required to be ensured;

suction (strong) is air suction. Connection through air source is required, and minimum air level is required to be kept.

The device is not connected with the negative pressure pump, dental suction machine.

### 4.3 Installation preparing

Determine the installation place according to the layout, light and using habit of treatment room. First, installation place should be clean, dry, shade and cool. Second, the ground of installation place should be flat and solid. Then, choose spacious place and open the package and make sure the dental unit can not touch surrounding things. Bury tube and wire according the below figure. The requirement of pipe is as following:

The exit of wire distance the ground 80mm.

The water inlet and air inlet use the water pipe which diameter is 36mm.

The inner diameter of drain pipe is 52mm, its exit distance the ground 50mm.

## 4.4 Installation

The installation diagram and step is as the following :

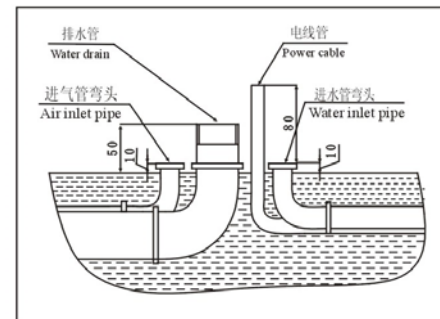
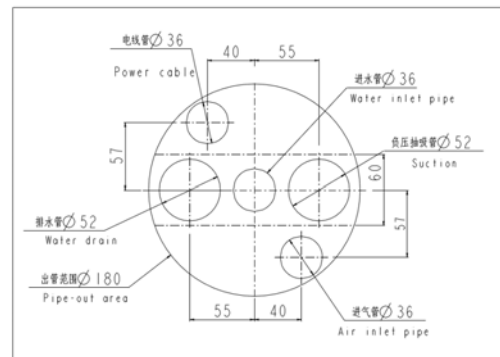
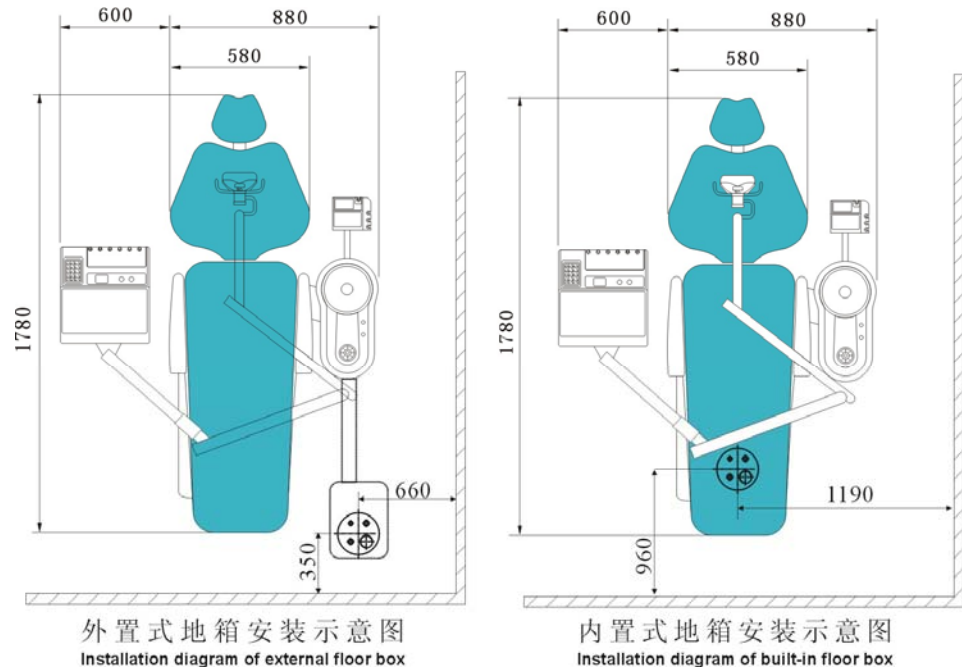

### 4.4.1 Installation of chair base

Put the unit on the installation place. If the ground of installation place is not flat, please fix chair base with six M12\*12 screws. Please keep chair base contact the ground as more as possible. Then fix chair base with four M10 expansion screw, to keep the unit stable and reduce the noise.

### 4.4.2 Installation of patient chair

Move backrest down, insert two round head screw and adjust patient chair to appropriate place, then tighten two screws.

### 4.4.3 Installation of pipe

Before connecting pipe, please discharge water and air in order to remove contaminant in unit and extent the life time of unit. Then insert drain-pipe of unit into drain-pipe of treatment room and fix drain-pipe

and keep the drain water smoothly.

#### 4.5 Debugging

After installation, connect the electric power, air source and water source with unit. Observe the pressure reading of air filter relief-pressure valve, if the reading is not 0.6mpa, adjust air filter relief-pressure valve and keep the pressure is 0.6mpa(The adjustment method of air filter relief-pressure valve is as followings, pull up the rotary switch on the top of valve, and rotate rotary switch to adjust the pressure, the pressure is up when clockwise. Conversely, the pressure is down).



## 5 Operation

### 5.1 Starting up the dental unit

#### 5.1.1 Initial startup

Sanitation must be performed prior to initial startup of your dental unit. Refer to “Cleaning and maintenance by the practice team” for more information.

Sanitation takes approx. 24 hours.

#### 5.1.2 Main switch

Following switch-on, the dental unit is connected to the power, water and air supply.



### ! NOTICE

On completing your work, you should switch the dental unit off with the main switch both for safety reasons and to reduce its power consumption.

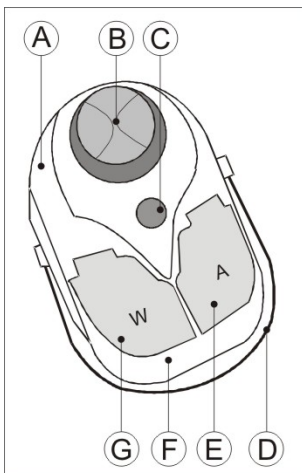

### 5.2 Foot control

The foot control comprises the following main components:

A	shell
B	Foot switch. (Control the patient chair movement.)
C	Chip blower switch
D	Positioning bar
E	Air pedal
F	Baseplate
G	Water pedal

#### Operating foot switch

The foot switch use to control movement of the patient chair. Uplifted or descending the chair couch movement can be controlled by sliding the foot switch to the up or down. Similarly, backward or forward backrest movement can be controlled by sliding the foot switch to the left or right.

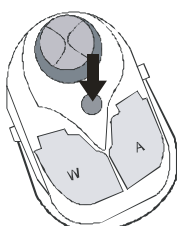
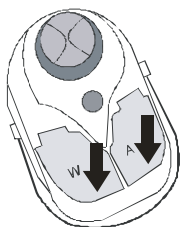

#### Air pedal and Water pedal

The handpiece is removed from its holder on the dentist element.

- Step on the air pedal. The handpiece motor rotates, and blowing chip air flows out the cooling holes on the handpiece.
- Step on the water pedal. Cooling water flows out from the cooling holes on the handpiece.

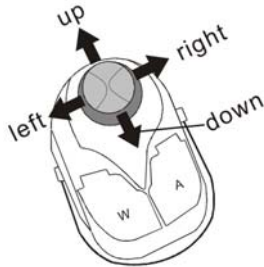

- Step on the air and water pedals simultaneously. The handpiece motor rotates during spraying the cooling spray.

### Chip blower switch

The handpiece is removed from its holder on the dentist element.

- Step on the button of the chip blower switch. Air flows out the cooling holes on the handpiece.

### 5.3 Patient chair

The patient chair comprises the following main components:

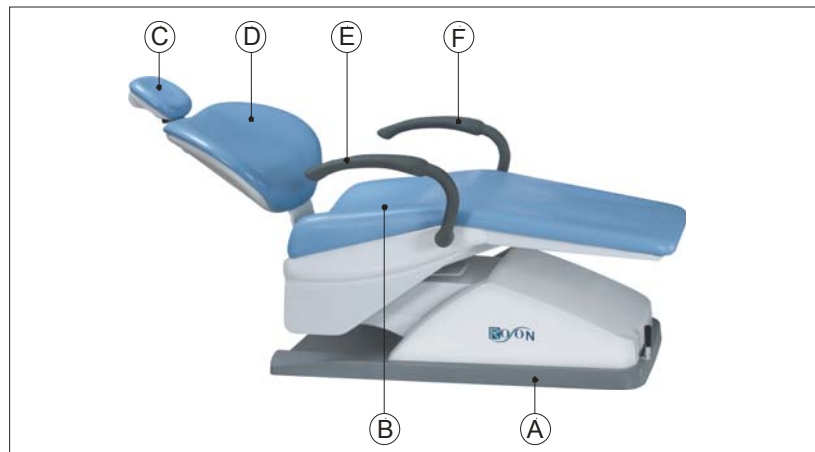

A	Chair base
B	Seat
C	Headrest
D	Backrest
E	Right armrest
F	Left armrest

### 5.3.1 Safety instructions



#### WARNING

**The free space under the patient couch and up to the water unit can be decreased due to chair movements.**

Parts of the patient's or user's body may be pinched or crushed.

- Do not allow any limbs to be caught between the chair upholstery and the chair base. Please make sure that the patient's arms and legs rest on the upholstery of the chair.
- Do not place any objects on the base of the chair.

**The maximum load capacity of the patient chair is 150 kg acc. to ISO 7494-1.**

If the maximum load capacity is exceeded, a risk of damage to the patient chair and injury of the patient exists.

Never allow any persons who weigh more than **150** kg to sit on the patient chair.

**Objects protrude into the movement range of the chair.**

There is a risk of crushing the patient and damaging the objects.

Make sure that no objects such as e.g. windows, drawers or other devices protrude into the movement range of the dental unit.

**Chair interlock**

As long as a treatment instrument is activated, all functions for moving the patient chair disabled for safety reasons.

**General warning**

- To avoid the risk of electric shock, this equipment must only be connected to a supply mains with protective earth.
- The device should be operated by professional medical staff.
- Please read the instruction for use carefully before using the device.
- The device is not AP/APG equipment. It is not suitable for use in the presence of a flammable anesthetic mixture with air (or oxygen, nitrous oxide).
- The device can not connect with other device to be used together except handpieces which have CE certificate.
- The manufacturer has considered the influence of electromagnetic interference. For normal use, keep the unit far away the conditions of strong electromagnetic field (e.g. mobile) that radiates interference signal or electrical fast transient / burst signal.
- If chair movement is permanently blocked, please contact your service engineer.
- The device just can be connected with specified detachable parts by manufacturer.

### 5.3.2 Armrest

The patient chair can be equipped with armrests on the both sides. The left armrest is stationary, and the right armrest can be swiveled up 180° for easier entry and exit. The swiveling method please see the left pictures. (For KLT-6220, please pull out the armrest and then swivel it.)

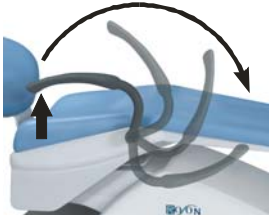

### 5.3.3 Adjusting the headrest

The headrest enables you to adjust the patient's head in a way that optimally supports viewing of hard-to-access areas of the patient's mouth.

#### Patient height adjustment

The headrest can be adjusted to the patient's height by pulling out or pushing in the headrest extension.

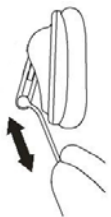

#### Setting the jaw position

The headrest enables you to change between the maxillary and mandibular positions without adjusting the headrest extension.

1. Press position A in the direction of the arrow to release, the headrest is unloaded.
2. Holding the headrest by hand, raise or lower it to the required position.
3. Release the press, the headrest is locked again.

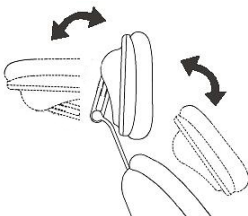
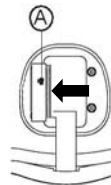

### Warning

Before operating, please lock headrest, loosed headrest will cause injury of patient.

### 5.3.2 Moving the patient chair

The chair movement can be controlled via the fixed keys on the dentist element and the assistant element, or via the foot switch.

#### Via the dentist element

Picture of the control panel on the dentist element, see "The control panel on the dentist element".

**Chair Up**



The chair couch moves up as long as the key (*Chair UP*) is pressed.

**Chair Down**



The chair couch moves down as long as the key (*Chair Down*) is pressed.

**Backrest Up**



The backrest tilts up as long as the key (*Backrest UP*) is pressed.

**Backrest Down**



The backrest tilts down as long as the key (*Backrest Down*) is pressed.

**Via the foot switch on the foot control**

See “4.2 Foot control/Operation foot switch”.

**5.3.3 Moving the patient chair to the entry/exit position**

The following functions are triggered for simple patient entry and exit in the entry/exit position:

- The patient chair moves to the lowest position
- The backrest moves to an upright position



Press and hold “R” key and moving the patient chair to the spittoon position can be implemented by pressed the key (R) on the dentist element or on the assistant element.

**WARNING**

**The patient’s feet may get caught in the instrument hoses of the dentist element when he enters of leaves the patient chair.**

The patient may trip or fall.

- Turn the dentist element outward before the patient enters of leaves it.

**5.3.4 Moving the patient chair to the general working position**

The following functions are triggered for simple dentist adjusting the best treatment position in the general working position:

- The patient chair moves up about 100 mm
- The backrest rotates backward about 50°



Press and hold “LP” key and moving the patient chair to the general working position can be implemented by pressed the key (LP) on the assistant element.■

**5.3.5 Emergency Stop**

Press Emergency Stop in emergency situations to disconnect power supply of actuator.

Turn Emergency Stop clockwise and release to unfreeze emergency situation.

If continuous movement is needed, turn this switch clockwise. The device will start to work again if the switcher leases automatically.

**Caution**

Give adequate attention to patients and this device when it is occupied, with a view to avoiding striking or squeezing the patient. Turn off system power immediately if this device moves accidentally and will not stop moving

**IMPORTANT**

The function that moving the patient chair to the general working position can be implemented only the patient chair stopping at the entry/exit position.

**5.4 Dentist element**

The dentist element comprises the following main components:

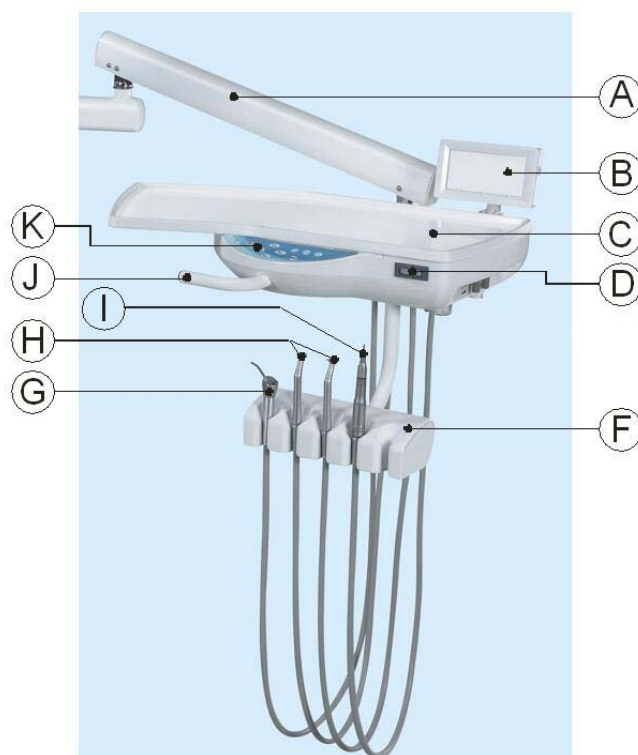

A	Support arm, height-adjustable
B	X-ray viewer
C	Instrument tray
D	Gas-pressure meter
F	Instrument holder
G	3-way syringe
H	High-speed handpiece(not include)
I	Low-speed handpiece(not include)
J	Handle
K	Control panel



**5.4.1 Maximum load capacity**

The maximum load of the dentist element is 2.5 kg.

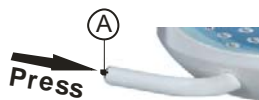

**5.4.2 Height adjustment**

1. Hold the handle and press the locking button (A) by the thumb.
2. Adjust the dentist element to achieve an ergonomic instrument height.
3. Loosen the thumb; the button automatically resets. The dentist element is locked on the height adjustment.

**5.4.3 The control panel on the dentist element**

The control panels are as following. KLT-6210 and KLT-6220 is touch key. In addition, the control panel of KLT-6220 adds 3 key, P1, P2, P3, for easy operation.

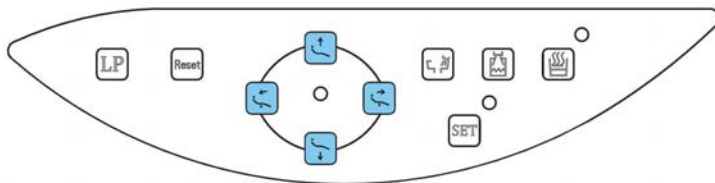

KLT-6210

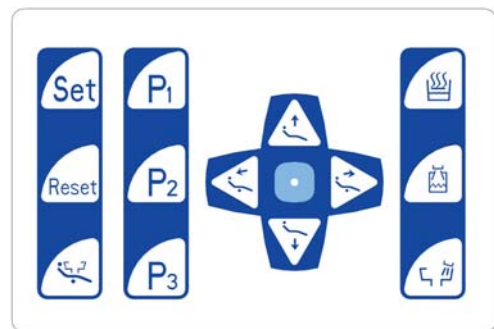

KLT-6220

**5.4.3.1 Chair movement area**

The keys in chair movement area control the patient chair movement. See “4.3.2 Moving the patient chair / Via the dentist element”.

**5.4.3.2 Water unit area**

**Tumbler filling**

**Tumbler Filling**



1. Place the tumbler under the tumbler filler.
2. Press the key (*Tumbler Filling*). The tumbler is filled with water for the preset time.

Pressing the key (*Tumbler Filling*) again stops the filling function immediately.

**Setting the filling time**

**Set**



1. Pressing the key (*Set*) (about 2second) until the buzzer in the water unit call. The LED above the key lights up.
2. Pressing the key (*Tumbler Filling*) until the filling water rise to the

desired position.

3. Press the key (*Set*) again finishes the setting the filling time. The LED above the key lights out.

### Flushing of the cuspidor bowl



Press the key (*Flushing*). The flushing function is activated for the preset flushing time.

Pressing the key (*Flushing*) again stops the flushing function immediately.

### Setting the flushing time



1. Pressing the key (*Set*) (about 2second) until the buzzer in the water unit call. The LED above the key lights up.
2. Press the key (*Flushing*) to set the flushing time. According to the following table:

Press Times	Buzzer Call	LED Flicker	Flushing time
<i>One time</i>	<i>One time</i>	<i>One time</i>	<i>30 minute</i>
<i>Twice</i>	<i>Twice</i>	<i>Twice</i>	<i>60 minute</i>
<i>Three times</i>	<i>Three times</i>	<i>Three times</i>	<i>Always flushing</i>
<i>Four times</i>	<i>Four times</i>	<i>Four times</i>	<i>12 second</i>

3. Press the key (*Set*) again finishes setting the flushing time. The LED above the key lights out.

### Heating of the tumbler water



Press the key (*Heating*). The heating function is activated. The tumbler water temperature can be kept at 40°C ± 5°C.

If the LED in the key is lighting, the heater in the water unit is working. Pressing the key (*Heating*) again stops the heating function immediately.

#### 5.4.3.3 Shortcut keys for KLT-6220

P1, P2, P3, are shortcut keys of chair position. The setting step of the four keys are as following:

1. Press chair movement keys to adjust the chair to your desired chair position;
2. Press P1 and P1 position setting done;
3. Press P1 and the chair will move to setting position;
4. P2, P3 is the same setting process.

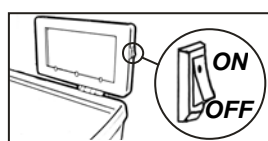

#### 5.4.4 X-ray viewer

- Press the switch on. The x-ray viewer lights up.
- Press the switch off. The x-ray viewer lights out.

#### 5.4.5 Placing the instruments in their holders

Every handpiece has a corresponding switch on the holder. When the



handpiece is removed to their holder, the switch will open the pile-up valve and the removed handpiece is unlocked.

Therefore, always make sure that all handpieces are placed in the correct instrument holders. If any handpieces are placed in the wrong holders, the removed handpieces will not be activated.

### NOTICE

Over-tensioning or pinching the hoses may cause the media pipes to leak. Ensure that you do not pull or bend the instrument hoses too much.

#### 5.4.6 Operating the handpieces

See "5.2 Foot Control".

### IMPORTANT

Also observe the operating instructions of the handpiece.

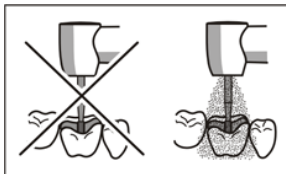

### WARNING

**Handpieces can be operated without coolant.**

Tooth substance can be damaged by frictional heat.

- Always make sure that the treatment area does not overheat whenever you switch the coolant off.

#### 5.4.7 Adjusting the handpiece's working air pressure and water flow

The handpiece's working air pressure and cooling water flow can be adjusted by their adjust valves. The control valves are shown in the following illustration.

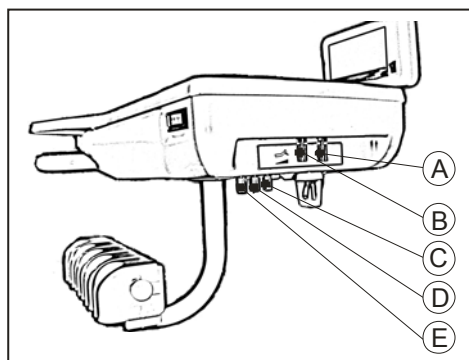

A	Water regulating valve
B	Blowing air regulating valve
C	Working air regulating valve of the handpiece in the fourth holder
D	Working air regulating valve of the handpiece in the third holder
E	Working air regulating valve of the handpiece in the second holder

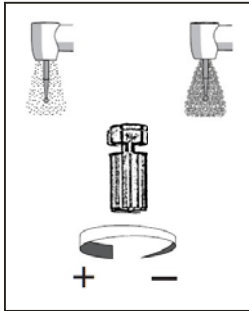

### Setting the spray amount

The spray amount can be set by adjusting the water regulating valve.

1. Remove the handpiece from its holder.
2. Step on the air pedal and the water pedal at the same time.
3. Set spray amount by turning the knob of the water regulating valve.
4. Check the set spray amount with a handpiece and correct the setting if necessary.



### Adjusting the chip blower air

1. Remove the handpiece from its holder.
2. Step on the button of the chip blower switch.
3. Set air flow by turning the knob of the blowing air regulating valve.

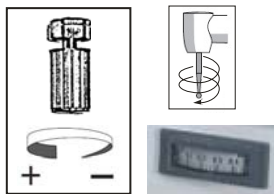

### Setting the handpiece's working air pressure

1. Remove the handpiece from its holder.
2. Step on the air pedal.
3. Set the working air pressure displayed on the Gas-pressure meter by turning the knob of the corresponding regulating valve. (Press: 1~3.2bar)

## 5.4.8 3-way syringe

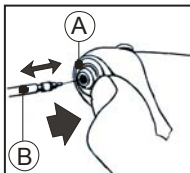

### Removing/attaching the tip

1. Press the ring (A).
2. Removing/attaching the tip (B).
3. Loosen the thumb; the ring automatically resets. The tip will be locked if it is attaching on the 3-way syringe.

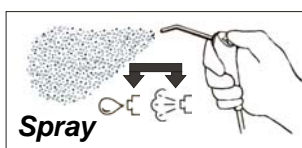
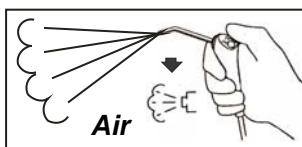
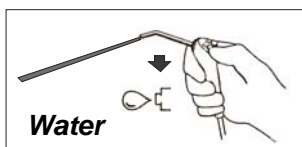

### Operating the 3-way syringe

- Press the water button. Water flows out the tip.
- Press the air button, Air flows out the tip. The 3-way syringe is used as a chip blower.
- Press the water and air buttons simultaneously. Spray flows out the tip.

## 5.5 Assistant element

The assistant element comprises the following main components:

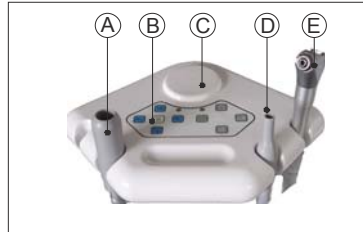

A	Spray aspirator
B	Control panel
C	Instruction holder
D	Saliva ejector
E	3-way syringe

### 5.5.1 Moving the assistant element

The assistant element can be moved in the dental assistant's field of activity, but can't be adjusted in height. Don't place anything on the assistant element.

#### NOTICE

**The assistant element can be positioned above or below the backrest.**

The patient could be pinched during chair movements or the chair could be damaged.

- Move the assistant element out of the collision zone before moving the patient chair.

### 5.5.2 The control panel on the assistant element

The control panel comprises two areas: chair movement area and water unit area.

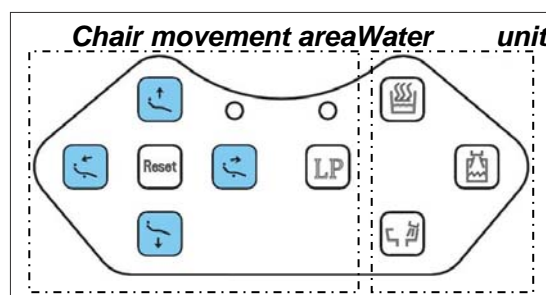

#### 5.5.2.1 Chair movement area

The keys in chair movement area control the patient chair movement. See "5.3.2 Moving the patient chair / Via the dentist element".

#### 5.5.2.2 Water unit area

The key functions are the same as the key functions on the dentist element. See “5.4.3.2 Water unit area”.

**5.5.3 3-way syringe**

See “5.4.8 3-way syringe”.



**5.5.4 Suction system**

A curved cannula that can be lodged in the corners of the mouth is provided for saliva ejection.

Saliva ejection can be used when it is removed from the holder.

The setting place of suction filter is as Section 5.6. The filter can filter particle which diameter is more than 2mm.

The filter need to be washed once every day and changed one year.

The suction system connect with internal negative pressure pump. In the strong suction hold, there is a switch to control open and close of strong suction.

Warning: The suction is single use. Please don't reuse it in case of cross-infection.

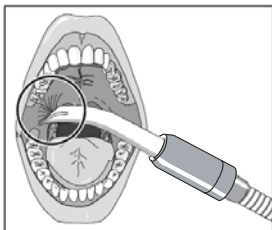
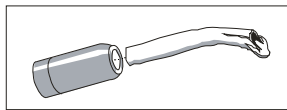

**5.5.5 Spray aspirator**

Spray aspirator can be used with its cannula when it is removed.

**⚠ NOTICE**

**The cannula attaches itself to the oral mucosa.**  
The patient's oral mucosa is irritated by the vacuum.

- Make sure to hold the spray aspirator cannula in such a way that the cannula opening cannot attach itself to the oral mucous membranes by accident.

**5.6 Water unit**

The water unit comprises the following main components:

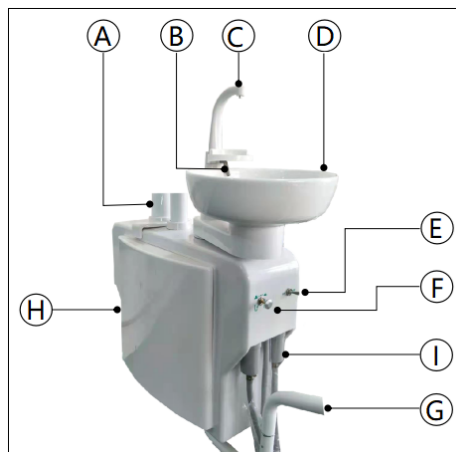

A	Support arm of the dentist element
B	Tumbler filler
C	Flusher
D	Swiveling cuspidor bowl
E	Air switch
F	Water alternative switch
G	Support arm of the assistant element
H	Pure water bottle
I	Suction Filter

### 5.6.1 Tumbler filler

**Tumbler Filling**



Tumbler filling can be achieved via the key (*Tumbler Filling*) on the dentist element or on the assistant element.

See "5.4.3.2 Water unit area / Tumbler filler".

### 5.6.2 Flushing the swiveling cuspidor bowl

**Flushing**



Flushing cuspidor can be achieved via the key (*Flushing*) on the dentist element or on the assistant element.

See "4.4.3.2 Water unit area / Flushing the cuspidor bowl".

### 5.6.3 Swiveling cuspidor bowl

The cuspidor on the water unit can be swiveled approx. 90° to the both sides.

### 5.6.4 Air switch



- The air switch is pulled to the *ON* position. Air is filled in the pure water bottle to supply the preset pressure for the pure water flowing to the dentist element.
- The air switch is pulled to the *OFF* position. Air pressure in the pure water bottle is taken off.
- The pressure is 2.0bar

### 5.6.5 Water alternative switch

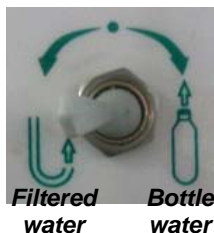

- The alternative switch is pulled to the *Filtered water* position. The water unit supplies filtered water for the instruments of the dentist element.
- The alternative switch is pulled to the *bottle water* position. The water unit supplies pure water from the pure water bottle for the instruments of the dentist element.

### 5.6.6 Pure water bottle

Pure water in the bottle is supplied for the instruments of the dentist element only when the air switch is pulled to the *NO* position and the alternative switch is pulled to the *Bottle water* position.

The bottle can be removed to pour pure water into it after the air switch much be pulled to the *OFF* position.

The bottle volume is 1L. During disinfection, you can put disinfectant into this bottle, and then disinfectant can flow all pipe for disinfecting internal pipe of the device.

Please note there is one pure water bottle for KLT-6210 and two pure water bottles for KLT-6220.



KLT-621



KLT-6220

## 5.7 Operating light

The operating light is attached to a height-adjustable support arm. It can be easily adjusted with the handgrips to illuminate the treatment area.

The operating light of KLT-6210 is LED-FSN/A. The operator can turn on and off the light according to symbol indication. The load-bearing of light arm is 1.2kg.

The operating light of KLT-6220 is LED-E. After turning on the light, operator can put hand 60-80cm in the distance of the light, the brightness can change gradually. The load-bearing of light arm is 1.5kg.

The installation of operating light:

Connecting wires of operating light and dental unit according to the color of wire, the same color wire can be connected together. Then put the operating light in light arm and fix with screws.

### IMPORTANT

Also observe the operating instructions of the operating light.

## 6 Cleaning and maintenance by the practice team

To maintain the value and safe functioning of your dental unit, it is necessary to have it cared for, cleaned and disinfected by the practice team regularly. This will minimize the risk of contamination for patients and users and ensure proper functioning.

Remove any dirt and disinfectant residues using a mild commercial cleaning agent.

The time intervals, operational approach and cleaning agent refer to the following table.

**IMPORTANT****Care and cleaning intervals**

The time intervals specified for disinfection, care and cleaning are reference values.

Please adapt the time intervals to suit your personal method of working and your national requirements.

**Medicaments chemically react with the surface of the unit.**

Due to their high concentrations and the substances they contain, many medicaments can dissolve, etch, bleach or discolor surfaces.

Clean any medicament residues off of the unit immediately with a moist cloth!

**NOTICE****Liquids can enter the unit during cleaning or disinfection**

Electrical components of the dental unit can be destroyed by liquids.

- Do not spray any liquids into the unit.
- To clean near openings, first spray the liquid onto a cleaning cloth. Then wipe over the unit with the cleaning cloth.

**Disinfectants can dissolve dyes in cleaning clothes.**

- The outer surface of the unit may then be discolored by the dye.
- Do not clean or disinfect the unit with colored cleaning clothes.

Intervals	Cleaning And Maintenance Items	Operational Approach	Care and Clean Agents
After each patient	Disinfect the upholstery	Wipe over surface with disinfectant.	65% alcohol solution
	Disinfect the control panels	Wipe over surface with disinfectant.	65% alcohol solution
	Disinfect all handles	Wipe over surface with disinfectant.	75% alcohol solution
	Clean and disinfect the cuspidor bowl	Wipe over the surface of the tumbler filler with disinfectant.	75% alcohol solution
		Activate the cuspidor flushing of the cuspidor bowl for least 30 second.	Cleaning water
	Disinfect and sterilize the treatment instruments	Wipe over the surface of the 3-way syringe with disinfectant. Sterilize the handpieces and the 3-way syringe tips.	75% alcohol solution Pressursteam sterilization, 134℃, 20min
Daily	Disinfect the suction handpieces	Wipe over the surface of the suction handpieces with Pumping 200mL cleaning water to flushing the suction hoses.	75% alcohol solution Cleaning water
	Cleaning the suction hoses		Cleaning water
	Purge water lines of the instruments	1. Removed the instruments from their holders and held over the cuspidor bowl. 2. Step on the water pedal of the foot control for purging. Press the water key of the 3-way syringe for purging. The purging time is for least 30 second.	Cleaning water
	Rinsing water lines	Activate the cuspidor flushing of the cuspidor bowl for least one minute	Cleaning water
	Disinfect the tray	Wipe over surface with disinfectant.	75% alcohol solution



Intervals	Cleaning And Maintenance Items	Operational Approach	Care and Clean Agents
Daily	Disinfect the suction hoses	Pumping 500 ml disinfectant to flushing the suction hoses.	1000mg/L available chlorine
Weekly	disinfect the water line of the cuspidor bowl	Wipe over surface with disinfectant. Pour 1 liter of the disinfectant into the cuspidor for flushing the water line.	75% alcohol solution 1000mg/L available chlorine
	Clean the foot control	Wipe over surface with a moist cloth (water).	Cleaning water
	Clean the filter of the suction device	Open the filter flask and clean the filter with disinfectant.	1000mg/L available chlorine
	Change the cotton wool in the return-air bottle	Unscrew the return-air bottle and remove the cotton wool roll. Insert new cotton wool roll and screw up the bottle.	
Monthly	Clean the water and air filters. Clean visible out side surface.	Open the water/air filter. Remove the filter element and clean it with cleaning water. Clean the surface.	Cleaning water
	Disinfect water lines of the instruments	<ol style="list-style-type: none"> <li>1. Remove the pure water bottle and fill disinfectant. Screw up the bottle again. Pull the air switch to the NO position and pull the water alternative switch to the <i>Bottle Water</i> position.</li> <li>2. Removed the instruments from their holders and held over the cuspidor bowl; step on the water pedal of the foot control for purging. Press the water key of the 3-way syringe for purging. The purging time is for least 4 hours.</li> <li>3. Purge the water lines again with the pure water. 30 s each water line.</li> </ol>	3% hydrogen peroxide

## 7 Maintenance by the service engineer

### 7.1 Inspection and maintenance

In order to ensure the operational safety and reliability of your dental unit and to avoid damage due to nature wear, annual inspection and maintenance must be performed on your dental unit. This is done by an authorized service engineer.

An overview of the inspection and maintenance work performed is additionally recorded by the service engineer in the "Warranty Passport".

### 7.2 Safety checks

Medical equipment is designed in such a way that the first occurrence of a fault does not create a hazard to the safety of patients, users or other persons. It is therefore important to detect such faults before a second fault occurs, which might then lead to safety hazards.

For that reason it is essential to perform safety tests every 2 years which aim particularly at detecting electrical faults (e.g. isolation defects). This is done by an authorized service engineer.



#### WARNING

The dental unit must not be operated if it has failed to pass the safety tests!

D001

Version: 2.2 10.2020

**34**Roson Dental Unit  
Operating Instructions KLT-6210、KLT - 6220

8 Malfunctions

## 8 Malfunctions

Some common fault is following table:

<b>Fault</b>	<b>Reason Analysis</b>	<b>action</b>
Dripping handpiece	The mebrane of the pile-up valve has been damaged	Change a new mebrane
	The water valve switching on by air has been damaged	Change a new water valve
Dripping 3-way syringe	The O-ring or the spring of the water button has been damaged	Change a new O-ring or a spring.
The tumbler filler can't be shut off.	Core of the solenoid valve has been jammed	Remove and clean the valve core.
The flusher can't be shut off.	Core of the solenoid valve has been jammed	Remove and clean the valve core.
The tumbler filler can't open.	The solenoid valve has been damaged	Change a new solenoid valve.
	The circuit board in the water unit has been damaged	Change a new circuit board
The flusher can't open.	The solenoid valve has been damaged	Change a new solenoid valve.
	The circuit board in the water unit has been damaged	Change a new circuit board
The heater can't work	The heater has been damaged	Change a new heater
	The circuit board in the water unit has been damaged	Change a new circuit board
The saliva ejector is not enough suction	Water pressure is not enough.	Please add supercharging equipment.
	The filter has been blocked by dirt	Open and clean the filter
The spray aspirator is not enough suction	Air pressure is not enough.	Increase air pressure by adjusting the reducing valve
	The filter has been blocked by dirt	Open and clean the filter
The patient chair is malfunction	The motor has been damaged	Change a new motor
	The circuit board controlling the chair motors has been damaged	Change a new circuit board
	Fuse on the circuit board has been damaged	Find out the cause and change a new fuse.
Operating light can't open	The circuit board in the operating light has been damaged	Change a new circuit board
	Fuse of the operating light has been damaged	Find out the cause and change a new fuse.

## 9 Disposal

The dental unit does not only **belong** to medical equipment, it also belongs to electronic equipment. The product must not be disposed of as domestic refuse!

Please observe the disposal regulations applicable in your country and dispose the device and its **accessories** according to local guidance.

Please contact your local dental equipment specialist for country –specific information on disposal.



### NOTICE

Prior to disassembly / disposal of the product, it must be fully prepared (cleaned / disinfected / sterilized).

No hydrargyrum segregator has been installed within the product; therefore, its drainage system cannot filter amalgam alloy. In order to avoid such pollution to the drainage system, the user shall install a hydrargyrum segregator additionally to avoid the drainage pollution

D001













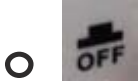









Version: 2.2 10.2020











36

Roson Dental Unit  
Operating Instructions KLT-6210、 KLT - 6220

10 Overview of graphic symbols used

## 10 Overview of graphic symbols used

symbols	Definition	symbols	Definition
	Switch on		Temperature limit
	Switch off		Atmospheric pressure limitation
	Chair up		Humidity limitation
	Chair down		electrical and electronic equipment
	Backrest up		Stacked layers much not be more than 2 lays
	Backrest down		Caution, consult accompanying documents
	Spittoon position		Type B applied parts
	General working position		The foot-operated can be protected against splashing water.
	Emergency stop		Caution, hot surface
	Cup filling		Manufacturer
	Cooling water adjustment		Date of manufacture
	Blowing air adjustment		Fragile-protect against knocks
	Filtered water		Keep dry
	Bottle water		Transport upright with the arrow pointing upwards

	Protective grounding		EU Authorized Representative
	Flushing (the cuspidor)		Warning, caution
	Heating		
	Set ( filling/flushing) time		
<b>Fuse</b>	Ø5X20 F6.3A H250VAC		Refer to the user manual.
	The operating light is Low-intensity lighting		The operating light is lighting
	The operating light is indirect lighting		

# 11 Electrical schematic diagram

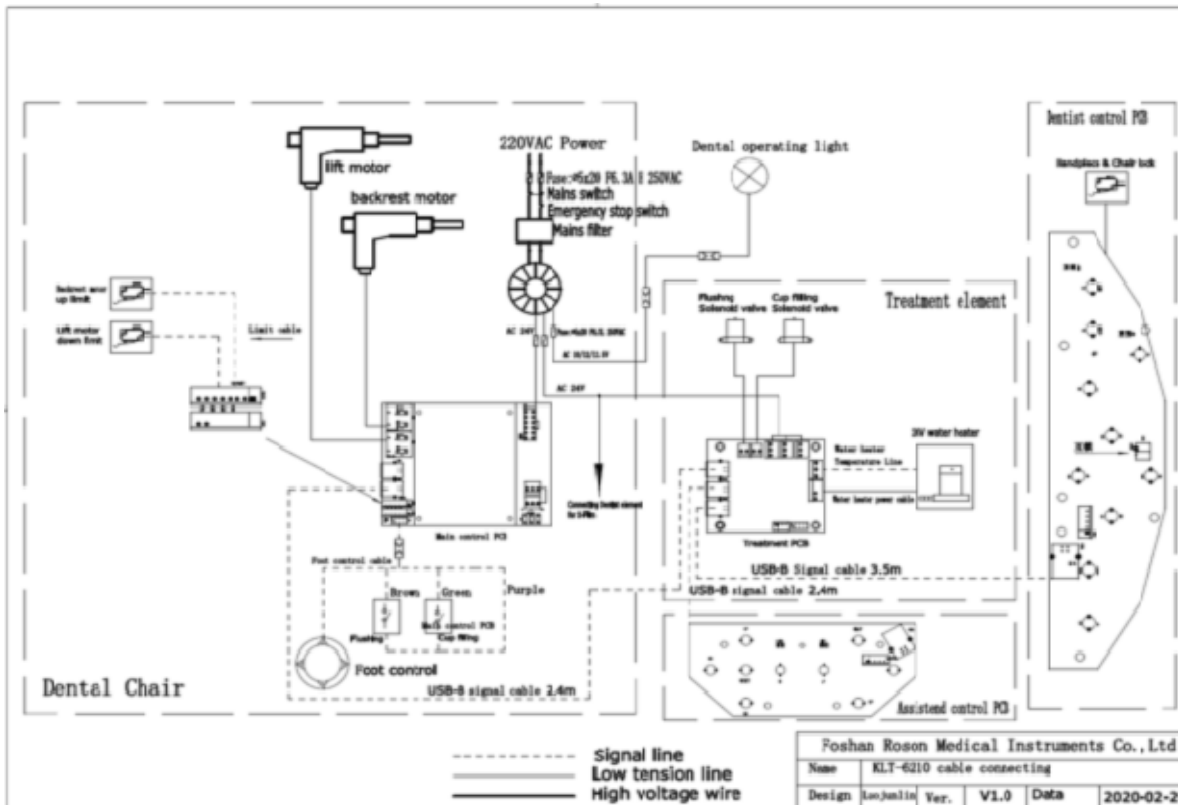
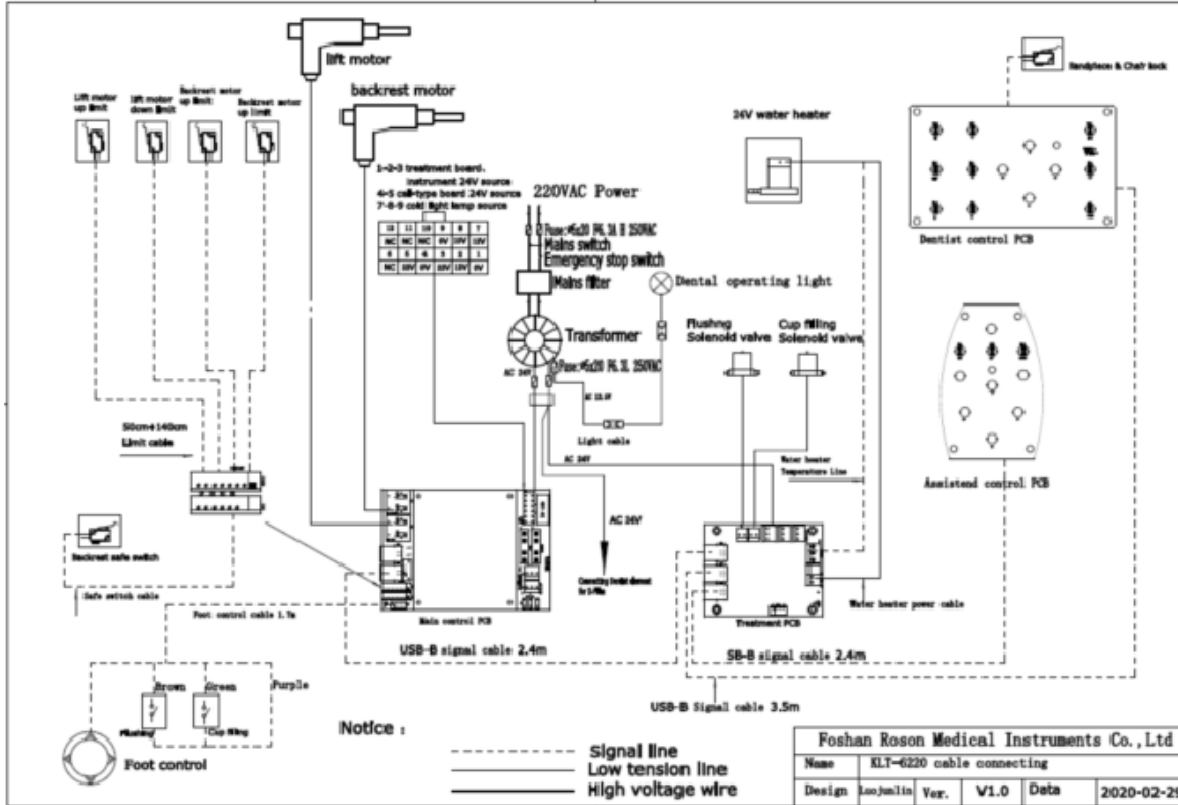

### 12 Water-air layout diagram

KLT-6210 水气原理图  
KLT-6210 water-air layout

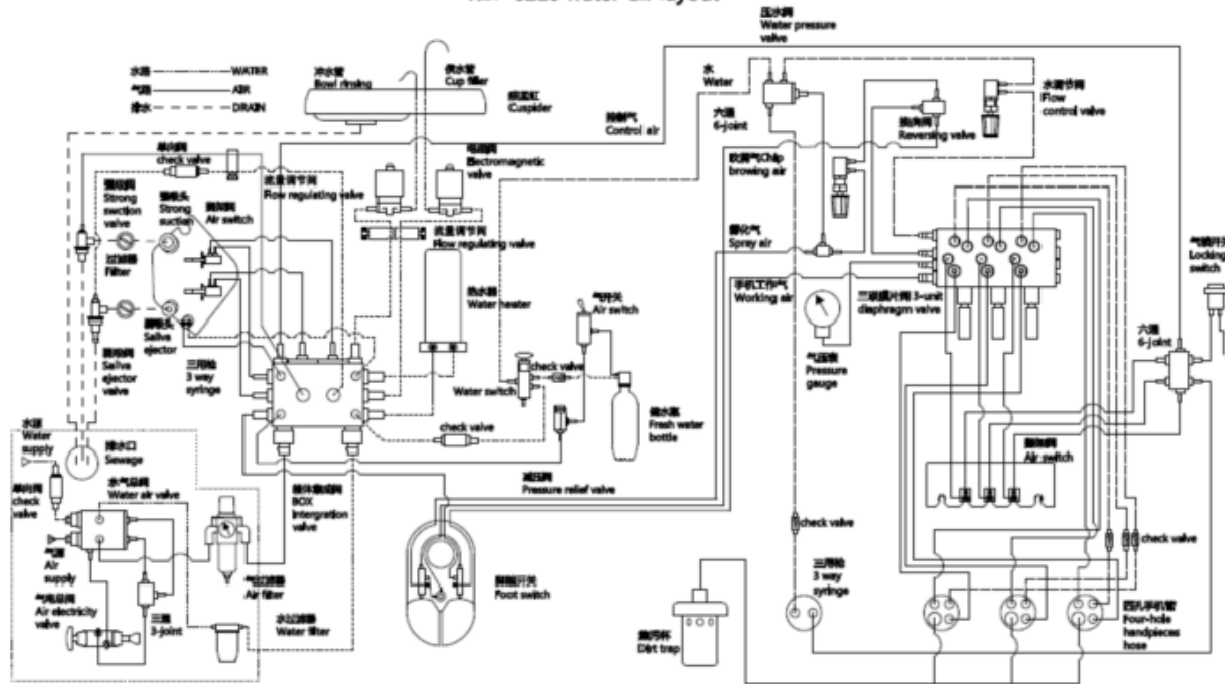

KLT-6220 水气原理图  
KLT-6220 water-air layout

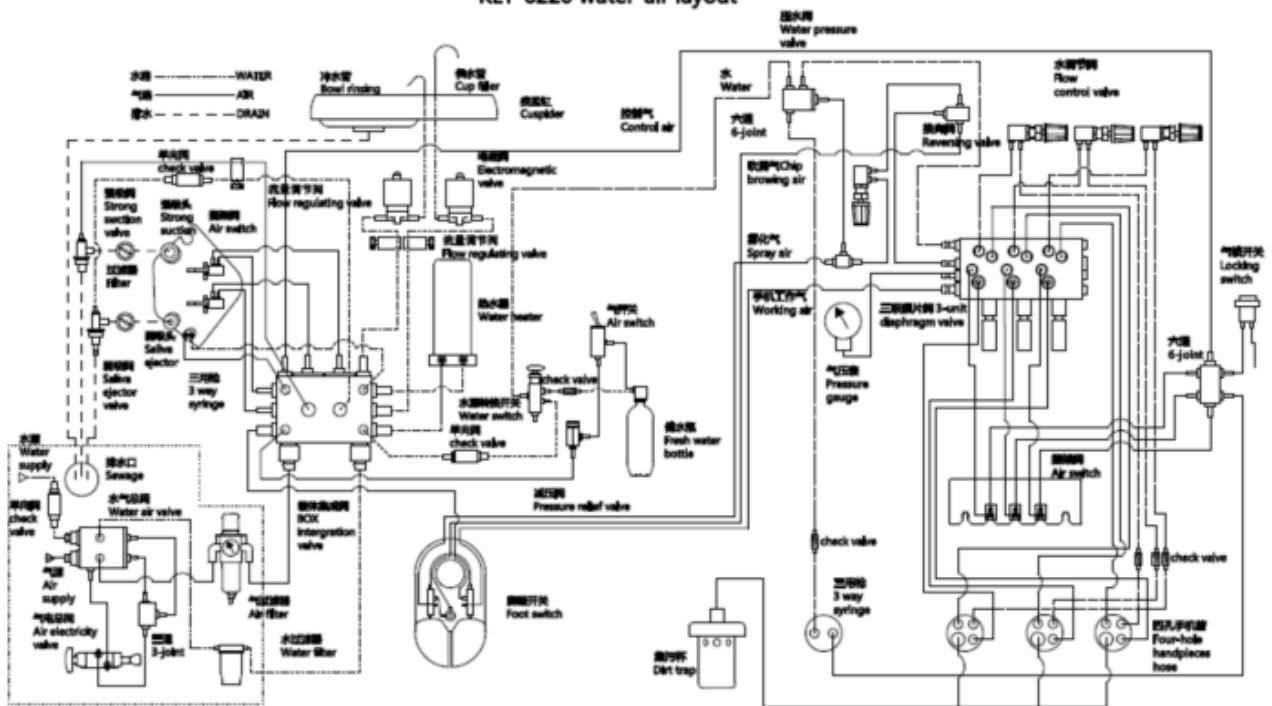



## 13 EMC Guidance

**Warning:** Don't use near active HF surgical equipment and the RF shielded room of an ME system for magnetic resonance imaging, where the intensity of EM disturbances is high.

**Warning:** Use of this equipment adjacent to or stacked with other equipment should be avoided because it could result in improper operation. If such use is necessary, this equipment and the other equipment should be observed to verify that they are operating normally.

**Warning:** Use of accessories, transducers, and cables other than those specified or provided by the manufacturer of this equipment could result in increased electromagnetic emissions or decreased electromagnetic immunity of this equipment and result in improper operation.

**Warning:** Portable RF communications equipment (including peripherals such as antenna cables and external antennas) should be used no closer than 12 in (30 cm) to any part of the equipment, including cables specified by the manufacturer. Otherwise, degradation of the performance of this equipment could result.

### Technical description:

1. All necessary instructions for maintaining BASIC SAFETY and ESSENTIAL PERFORMANCE with regard to electromagnetic disturbances for the expected service life.
2. Guidance and manufacturer's declaration -electromagnetic emissions and Immunity

Guidance and Manufacturer's Declaration – Electromagnetic Emissions	
Emissions test	Compliance
RF emissions CISPR 11	Group 1
RF emissions CISPR 11	Class B
Harmonic emissions IEC 61000-3-2	Class A
Voltage fluctuations/ flicker emissions IEC 61000-3-3	Complies

<b>Guidance and Manufacturer's Declaration – Electromagnetic Immunity</b>		
<b>Immunity Test</b>	<b>IEC 60601-1-2 Test level</b>	<b>Compliance level</b>
Electrostatic discharge (ESD) IEC 61000-4-2	±8 kV contact ±2 kV, ±4kV, ±8 kV, ±15 kV air	±8 kV contact ±2 kV, ±4kV, ±8 kV, ±15 kV air
Electrical fast transient/burst IEC 61000-4-4	±2 kV for power supply lines ±1 kV for input/output lines	±2 kV for power supply lines ±1 kV for input/output lines
Surge IEC61000-4-5	± 1 kV line(s) to line(s) ± 2 kV line(s) to earth	± 1 kV line(s) to line(s) ± 2 kV line(s) to earth
Voltage dips, short interruptions and voltage variations on power supply input lines IEC 61000-4-11	0 % $U_T$ ; 0.5 cycle at 0°,45°,90°, 135°, 180°, 225°, 270°, 315° 0 % $U_T$ ; 1 cycle 70 % $U_T$ ; 25/30 cycle 0% $U_T$ ; 250/300 cycle	0 % $U_T$ ; 0.5 cycle at 0°,45°,90°, 135°, 180°, 225°, 270°, 315° 0 % $U_T$ ; 1 cycle 70 % $U_T$ ; 25/30 cycle 0% $U_T$ ; 250/300 cycle
Power frequency magnetic field IEC 61000-4-8	30 A/m 50Hz/60Hz	30 A/m 50Hz/60Hz
Conducted RF IEC61000-4-6	3 V r.m.s.  150 kHz to 80 MHz 6 V RMS in the ISM and amateur bands between 0.15 MHz and 80 MHz	3 V r.m.s.  150 kHz to 80 MHz 6 V RMS in the ISM and amateur bands between 0.15 MHz and 80 MHz
Radiated RF IEC61000-4-3	10 V/m  80 MHz – 2,7 GHz 80 % AM at 1 kHz	10 V/m  80 MHz – 2,7 GHz 80 % AM at 1 kHz
NOTE $U_T$ is the a.c. mains voltage prior to application of the test level.		

<b>Guidance and Manufacturer's Declaration - IMMUNITY to proximity fields from RF wireless communications equipment</b>					
<b>Immunity test</b>	<b>IEC60601 test level</b>				<b>Compliance level</b>
	<b>Test frequency</b>	<b>Modulation</b>	<b>Maximum power</b>	<b>Immunity level</b>	
Radiated RF IEC 61000-4-3	385 MHz	**Pulse Modulation: 18Hz	1.8W	27 V/m	27 V/m
	450 MHz	*FM+ 5Hz deviation: 1kHz sine	2 W	28 V/m	28 V/m
	710 MHz 745 MHz 780 MHz	**Pulse Modulation: 217Hz	0.2 W	9 V/m	9 V/m
	810 MHz 870 MHz 930 MHz	**Pulse Modulation: 18Hz	2 W	28 V/m	28 V/m
	1720 MHz 1845 MHz 1970 MHz	**Pulse Modulation: 217Hz	2 W	28 V/m	28 V/m
	2450 MHz	**Pulse Modulation: 217Hz	2 W	28 V/m	28 V/m
	5240 MHz 5500 MHz 5785 MHz	**Pulse Modulation: 217Hz	0.2 W	9 V/m	9 V/m
	<p>Note* - As an alternative to FM modulation, 50 % pulse modulation at 18 Hz may be used because while it does not represent actual modulation, it would be worst case.</p> <p>Note** - The carrier shall be modulated using a 50 % duty cycle square wave signal.</p>				